



# باشگاه سرآمدان صادرات دانش بنیان

Iran Hi-Tech Export  
Companies Club (IHTECC)

ارتقای برند ملی ایران در عرصه هایتک | اسفندماه ۱۴۰۰





درباره باشگاه

# تاریخچه

ارزیابی  
تدوین چهارچوب  
مطالعات اولیه و  
طرح ایده،

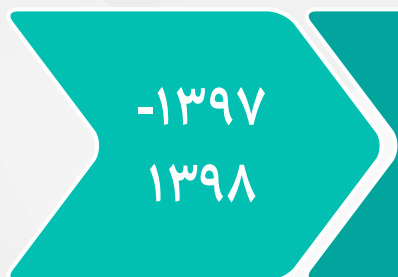

تصویب طرح  
در مرکز  
تعاملات



ارزیابی ۳۳۳  
شرکت



آذرماه  
۱۳۹۹



ارزیابی ۶۰۰  
شرکت



ارائه طرح به  
معاون علمی

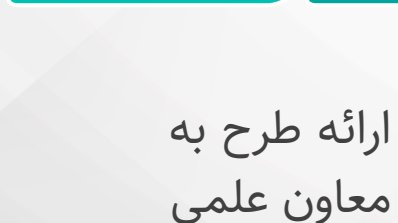

ارزیابی ۲۳۲  
شرکت

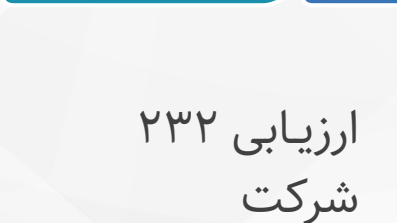

ارزیابی ۵۱۳  
شرکت

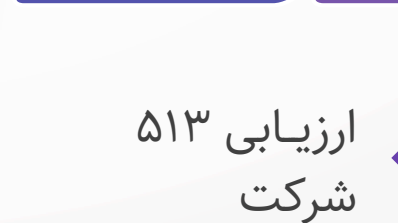

# هدف اصلی باشگاه

## تقویت برند ملی و تغییر نگرش کشورها نسبت به ظرفیت محصولات ایرانی

ایجاد و اعطای برچسب کیفیت ایران (IQL) به محصولات تأییدشده



نظارت بر فرآیند صادرات شرکتها:

- « تأیید کیفیت محصول و یا خدمت و جلوگیری از صادرات محصولات ضعیف
- « اطمینان از ارائه خدمات پس از فروش مناسب و انجام به موقع تعهدات شرکتها
- « اطمینان از گارانتی محصول توسط شرکت
- « نظارت بر رفتار حرفه‌ای شرکتها



تشکیل هیأت‌هایی از شرکت‌های عضو باشگاه جهت همراهی با مسئولین کشور:

- « معاون علمی و فناوری، وزیر خارجه، وزیر صمت و...



# وضعیت برند ملی کشورها

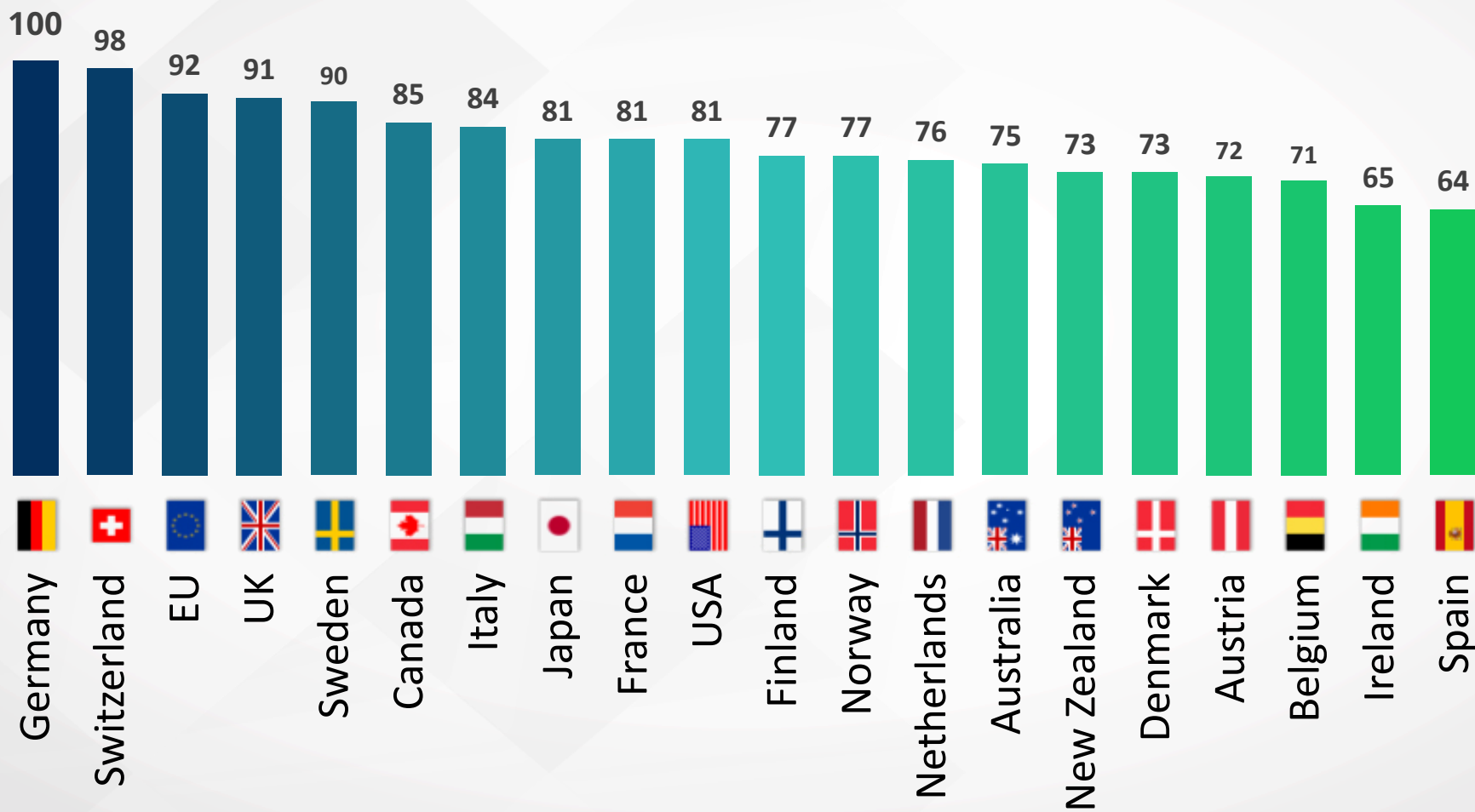

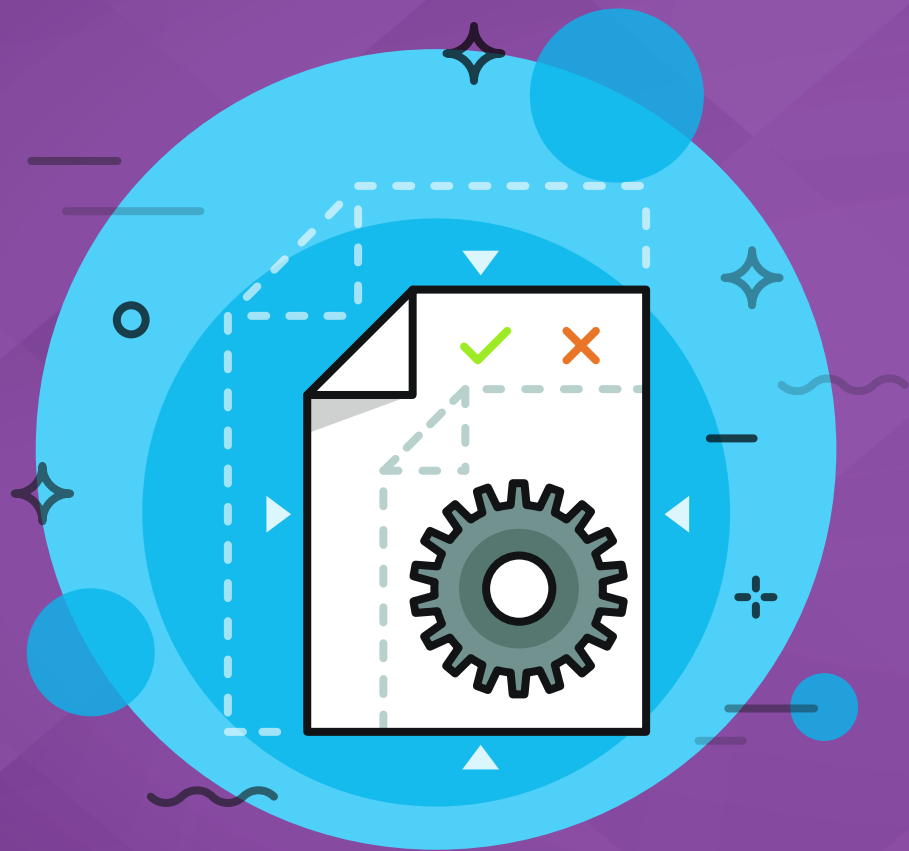

# وظایف باشگاه

# وظایف باشگاه

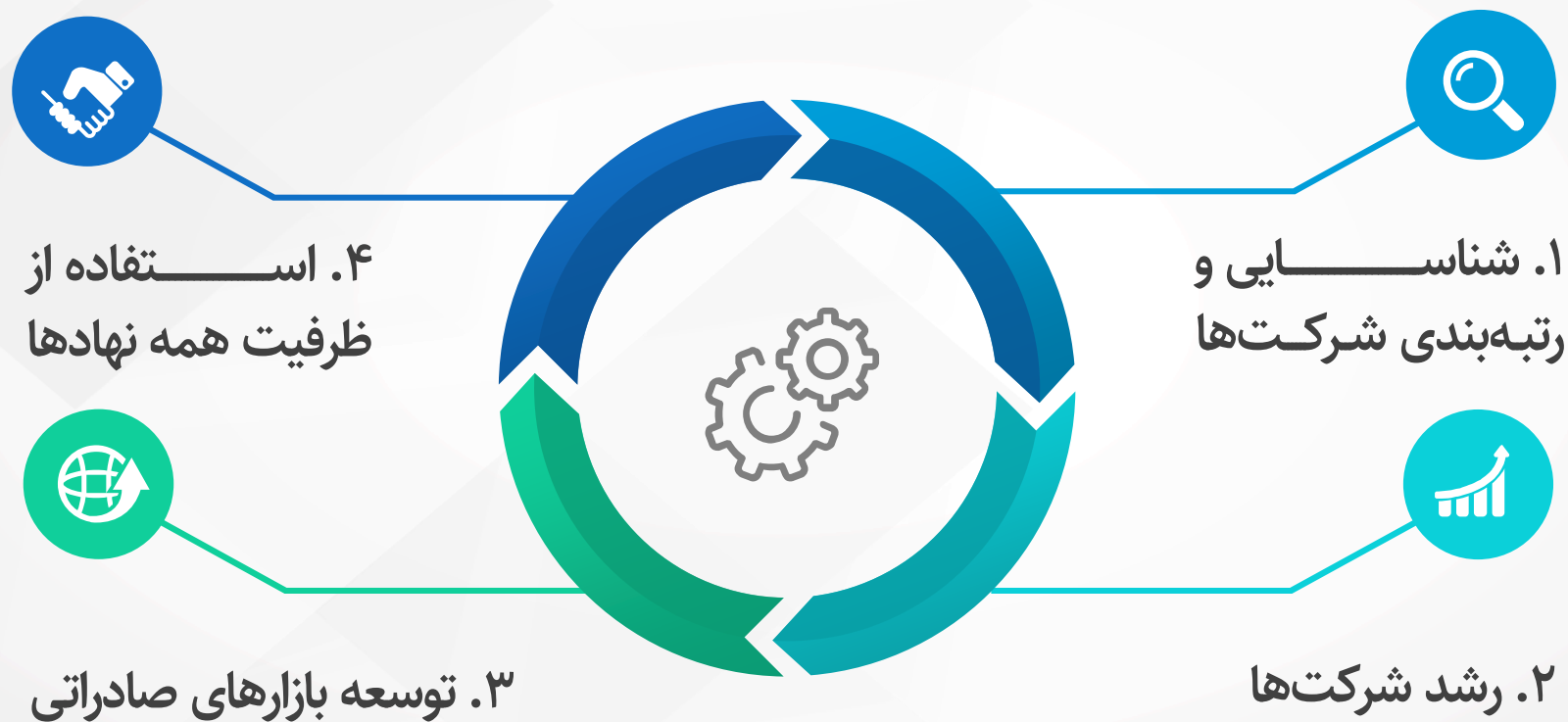

## رویکرد فعالانه در ارزیابی، رشد و توسعه بازار شرکت‌ها

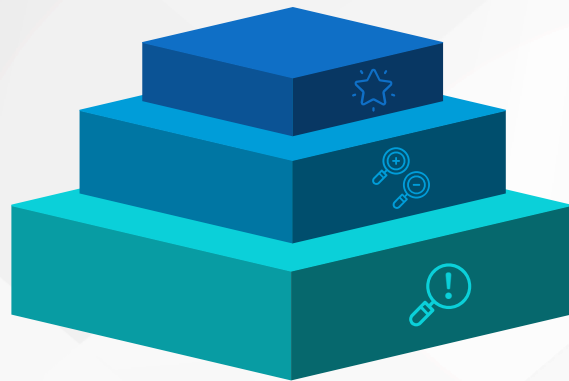

اجرای برنامه توانمندسازی برای هر شرکت



شناسایی نقاط قوت و ضعف هر شرکت



عارضه‌یابی صادراتی شرکت‌ها

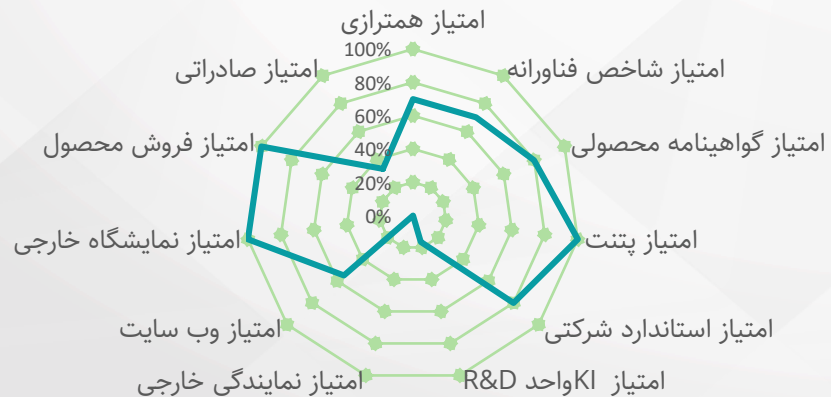

طراحی و مهندسی سیستم

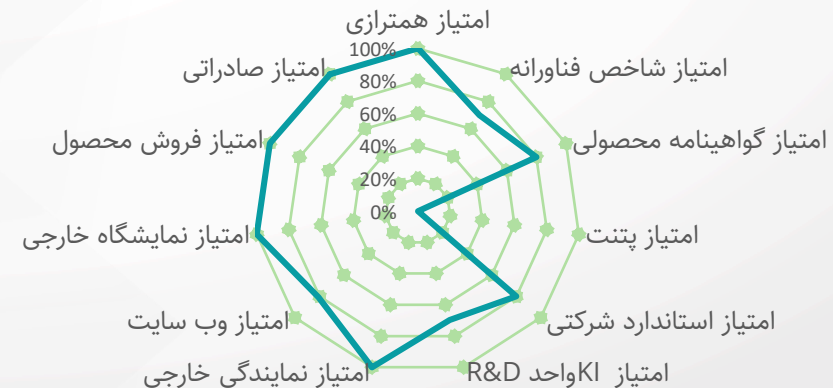

آریوزن فارمد

# توسعه بازارهای صادراتی



پشتیبانی شرکت‌ها در تأمین منابع مالی و پیدا کردن سرمایه‌گذار داخلی؛

دریافت وام برای مشارکت در سرمایه‌گذاری Joint Venture؛

ایجاد صندوق سرمایه‌گذاری خارجی برای تولید محصولات Hi-Tech در خارج از کشور؛



تسهیل صدور ضمانتنامه برای دریافت پیش‌پرداخت؛

تأمین وام کم‌بهره برای شرکت‌ها به منظور تأمین سرمایه برای تولید محصولات و صادرات قسطی؛

# توسعه بازار خدمات تخصصی



# فعال سازی ظرفیت وزارتخانه ها، دستگاهها و نهادها

## تمرکز وزارت صمت (سازمان توسعه تجارت) بر حوزه های تک



- تجمیع مشوق های صادراتی شرکت های عضو باشگاه
- حمایت از حضور شرکت های عضو باشگاه در نمایشگاه های تخصصی
- حمایت از حضور شرکت های عضو باشگاه در نشست های B2B

معاونت علمی و فناوری، وزارت امور خارجه، وزارت صمت، وزارت بهداشت، صندوق نوآوری و شکوفایی، وزارت اطلاعات و ...



# ویژگی‌های باشگاه

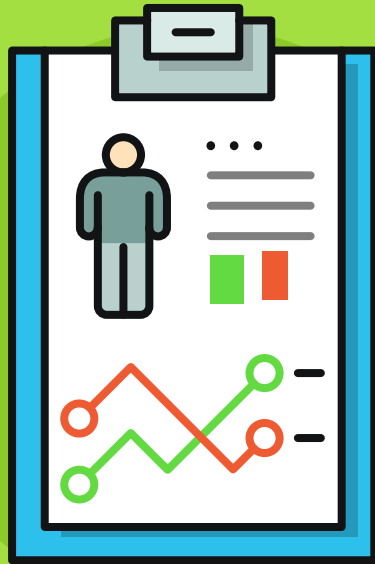

# ویژگی‌های باشگاه

غیردولتی (ثبات در مدیریت و برنامه‌ریزی)؛

مورد تایید و حمایت نهادهای دولتی و عمومی مرتبط با نوآوری؛



عدم ورود به عرصه‌های غیر دانش‌بنیان؛

خودگردان مالی (در آینده با دریافت حق عضویت از اعضا)؛



# آمار شرکت‌ها

# معیارهای ارزیابی و رتبه‌بندی

لزوم ساخت ایران بودن؛



دارای تیم R&D متخصص؛



دارای توان تولید انبوه؛



دارای مجوزهای لازم کیفیت عملکردی؛



دارای سابقه فروش داخلی؛



دارای سابقه صادراتی؛



دارای محصول Hi-Tech؛



دارای کیفیت مطلوب از نظر طراحی صنعتی؛



دارای رفتار حرفه‌ای در تعاملات بین‌المللی؛



دارای وبسایت مطلوب به زبان انگلیسی؛



دارای قابلیت رقابت از نظر قیمت؛



دارای ظرفیت ارائه خدمات پس از فروش بین‌المللی؛



دارای تأییدیه‌ها و استانداردهای بین‌المللی؛



دارای پتنت و یا عدم نقض پتنت.



## شاخص‌های ارزیابی

وزن	شاخص	محور (وزن)
۲۰	امتیاز فنی محصولات هایتک	فنی ۳۴
۹	گواهینامه محصولی	
۵	پتنت	
۵	عمق دانشی شرکت	شرکتی ۳۳
۱۰	زیرساخت فروش و خدمات پس از فروش	
۷	استاندارد شرکتی	
۸	زیرساخت اطلاع‌رسانی خارجی	
۳	حضور در نمایشگاه خارجی	
۲۳	صادرات	فروش ۳۳
۱۰	فروش داخلی	

# وضعیت باشگاه (بهمن ماه ۱۴۰۰)

۵ ستاره 

۶ شرکت

۴ ستاره 

۳۴ شرکت

۳ ستاره 

۲۵۹ شرکت

مستعد 

۱۴۵ شرکت

عدم احراز شرایط 

۱۵۶ شرکت

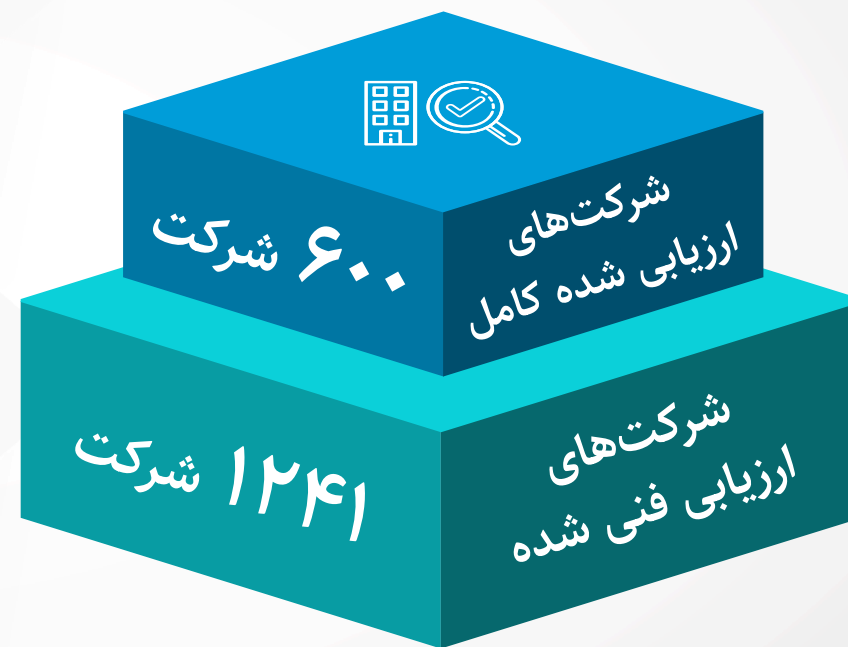

# فراوانی شرکت‌ها در سطوح مختلف

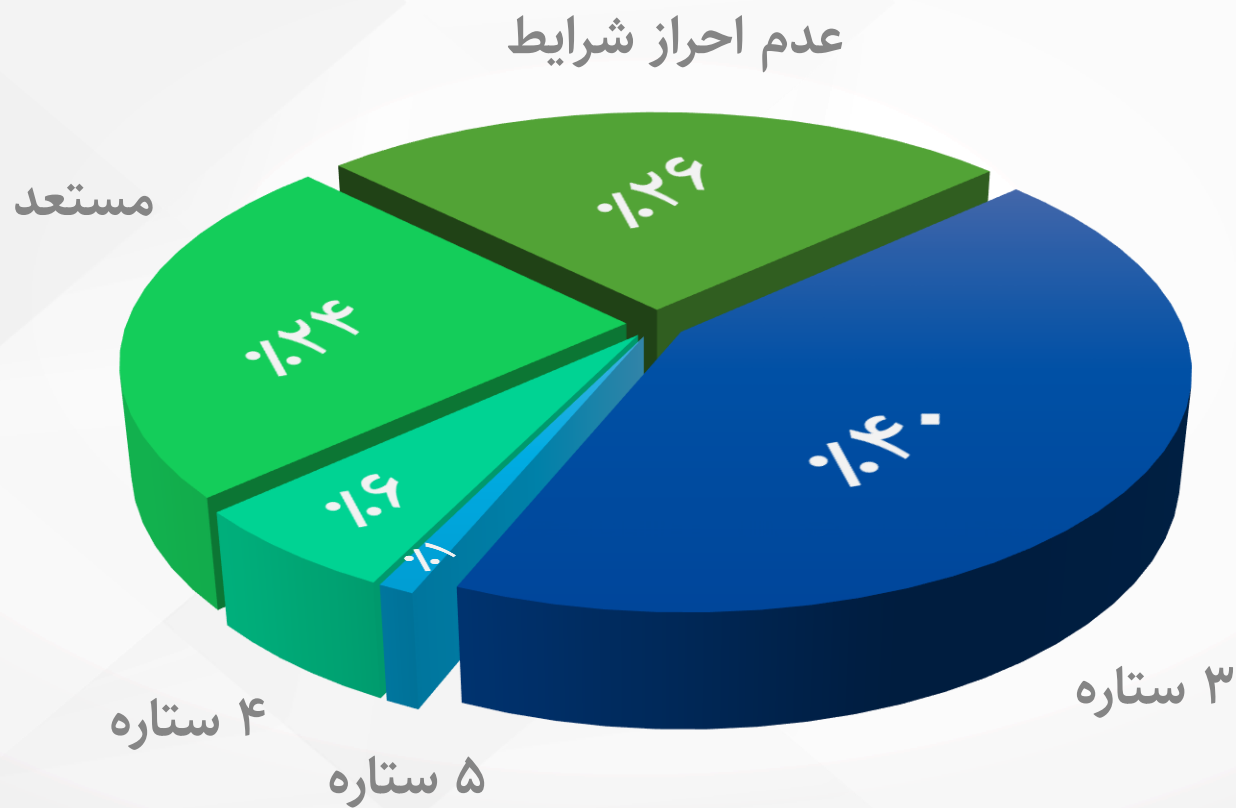

# توزیع شرکتها در حوزه‌های فناوری

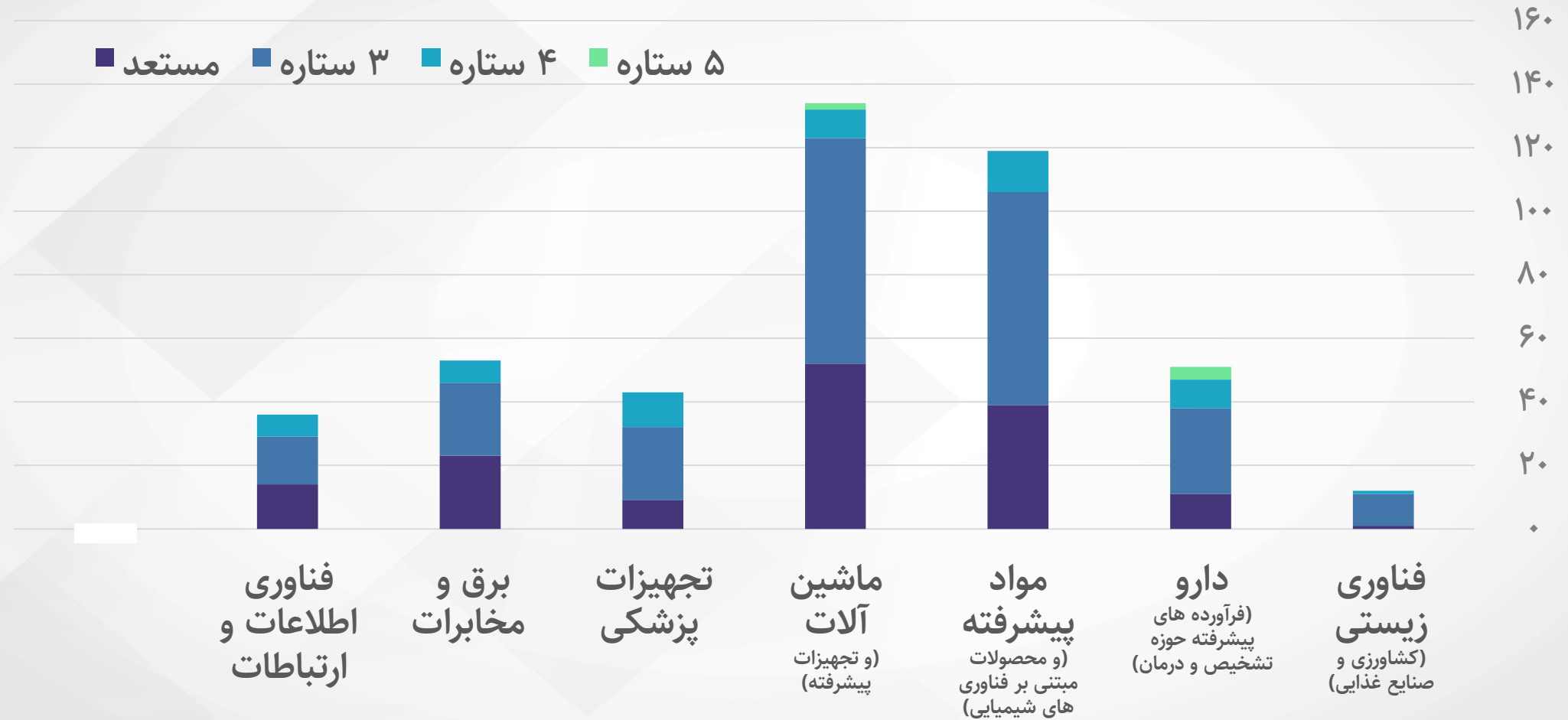

# توزیع شرکتها در حوزه‌های صنعتی

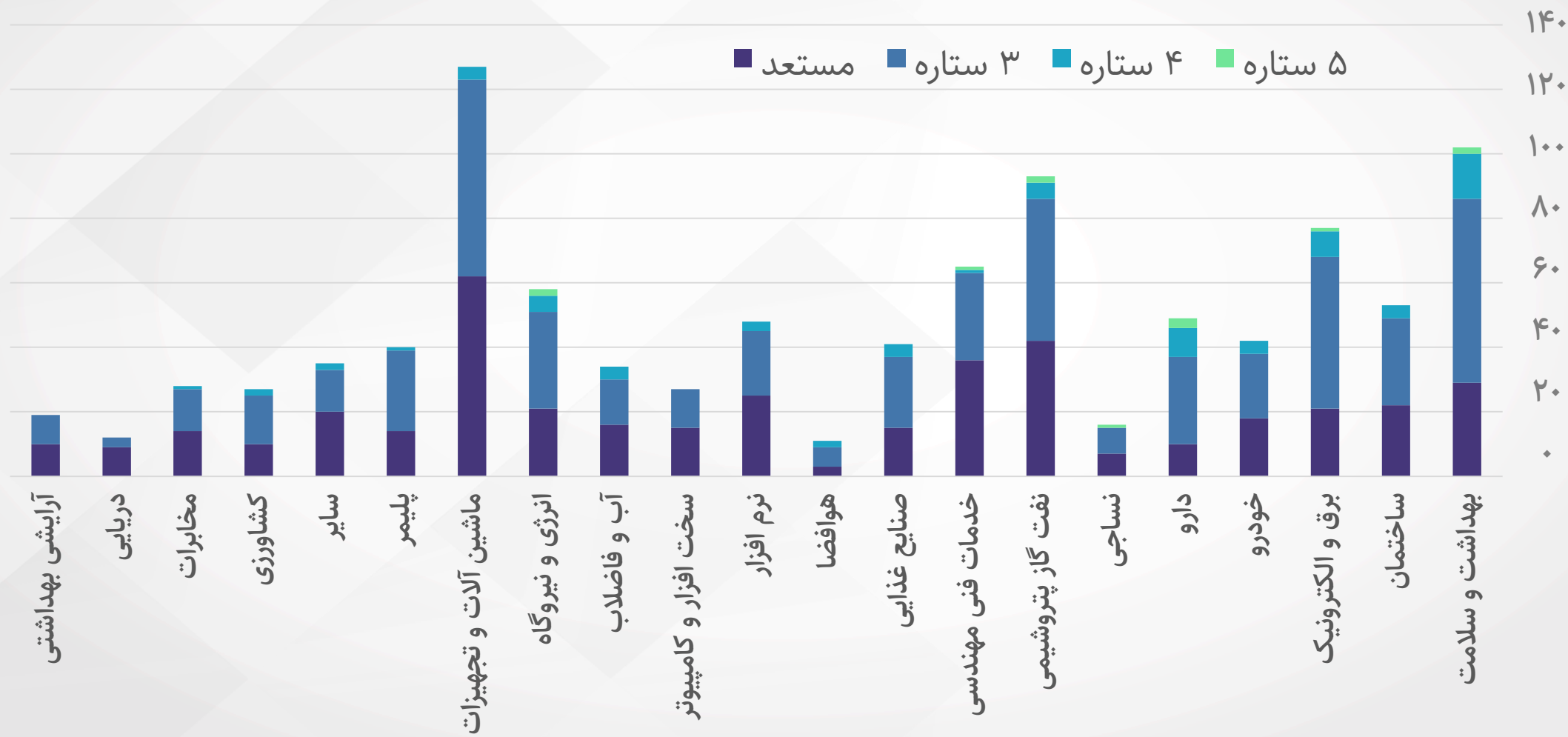



# لیست شرکت‌های ارزیابی شده

## شرکت‌های پنج ستاره



۶

تعداد شرکت‌ها



۳۵

تعداد محصولات



# شروط احراز سطح ۵ ستاره



## شرکت‌های ۵ ستاره

نام شرکت	امتیاز کلی	سطح فنی (حداقل ۱۲ از ۲۰)	پتنت یا عدم نقض پتنت	حداقل ۱ میلیون دلار صادرات
تحقیقاتی و تولیدی سینا ژن	۸۹	✓	✓	✓
آریوژن فارمد	۸۸	✓	✓	✓
مهندسی و ساخت توربین مپنا توگا	۸۶	✓	✓	✓
پیش‌تاز طب زمان	۸۳	✓	✓	✓
فراورده‌های پویش دارو	۸۱	✓	✓	✓
فناوران نانو مقیاس	۸۰	✓	✓	✓

# شرکت‌های ۵ ستاره



## شرکت تحقیقاتی و تولیدی سیناژن

آدرس: تهران، شهرک غرب، خیابان سیمای ایران، خیابان هفتم، پلاک ۲

تلفن: +۹۸ ۲۱ ۴۲۸۱۵  
فکس: +۹۸ ۲۱ ۸۸۵۶۱۵۷۵  
cinnagen.com  
info@cinnagen.com



## شرکت آریوژن فارمد

آدرس: تهران، شهرک غرب، خیابان سیمای ایران، خیابان هفتم، پلاک ۲

تلفن: +۹۸ ۲۱ ۴۲۸۱۵  
فکس: +۹۸ ۲۱ ۸۸۵۶۱۵۷۵  
aryogen.com  
info@cinnagen.com



## شرکت مهندسی و ساخت توربین مپنا توگا

آدرس: تهران، شهرک غرب، خیابان سیمای ایران، خیابان هفتم، پلاک ۲

تلفن: +۹۸ ۲۱ ۴۲۸۱۵  
فکس: +۹۸ ۲۱ ۸۸۵۶۱۵۷۵  
mapnaturbine.com  
info@cinnagen.com



## شرکت پیشتاز طب زمان

آدرس: تهران، شهرک غرب، خیابان سیمای ایران، خیابان هفتم، پلاک ۲

تلفن: +۹۸ ۲۱ ۴۲۸۱۵  
فکس: +۹۸ ۲۱ ۸۸۵۶۱۵۷۵  
pooyeshdarou.com  
info@cinnagen.com



## شرکت فراورده‌های پویش دارو

آدرس: تهران، شهرک غرب، خیابان سیمای ایران، خیابان هفتم، پلاک ۲

تلفن: +۹۸ ۲۱ ۴۲۸۱۵  
فکس: +۹۸ ۲۱ ۸۸۵۶۱۵۷۵  
pishtazteb.com  
info@cinnagen.com



## شرکت فناوران نانو مقیاس

آدرس: تهران، شهرک غرب، خیابان سیمای ایران، خیابان هفتم، پلاک ۲

تلفن: +۹۸ ۲۱ ۴۲۸۱۵  
فکس: +۹۸ ۲۱ ۸۸۵۶۱۵۷۵  
fnm.ir  
info@cinnagen.com

# محصولات شرکت های ۵ ستاره





**CinnoVex®**  
(interferon beta-1a)



**ReciGen®**  
(Interferon beta-1a)



**Cinnomer®**  
(Glatiramer Acetate)



**CinnoTec®**  
(Dimethyl Fumarate)



**CinnaFact®**  
(Buserelin Acetate)



**Cinnal-f®**  
(follitropin alfa)



CinnoPar®  
(Teriparatide)



PegaGen®  
(Pegylated Filgrastim)



CinnaPoietin®  
(Erythropoietin  $\beta$ )



CinnaTropin®  
(Somatropin)



Melitide®  
(Liraglutide)



CinnoRA®  
(Adalimumab)



AryoTrust™



AryoSeven™



Altebrel



Zytux™



Stivant™



Temziva™



Gas Turbine  
MGT-30

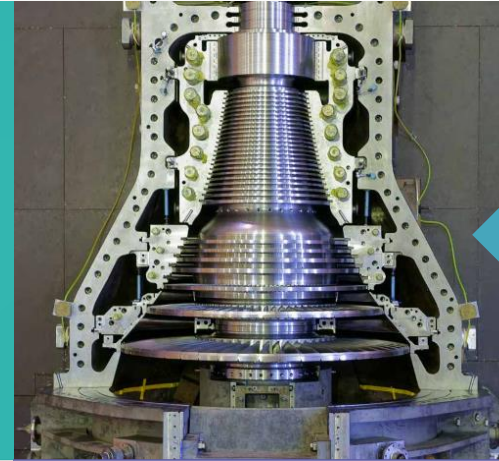

Steam Turbine  
MST-50C

Centrifugal  
Compressor

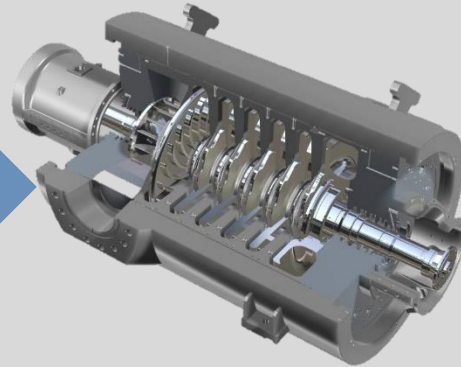

Gas Turbine  
MGT-70



## TSH Elisa Kit



## COVID-19 One-Step RT-PCR



## Biochemistry Kits



## Elisa Kits





**Pooyesh Darou**  
Biopharmaceutical Co.

pooyeshdarou.com  
info@pooyeshdarou.com

# محصولات Pooyesh Darou Co.



**PDFERON-B**



**PDgrastim®**



**PDlasta® (pegfilgrastim)**



**Erythropoietin (EPO) PDpoetin®**



**PDgrowth®**



fnm.ir  
info@fnm.ir

# محصولات FNM Co.



Capillary Electrophoresis



High Voltage Power Supplies

Syringe Pump



Industrial Nanofiber Production Line (INFL)



## شرکت‌های چهار ستاره



۳۴ تعداد شرکت‌ها 

۹۴ تعداد محصولات 

## شروط احراز سطح ۴ ستاره

داشتن محصول هایتک با  
حداقل ۵۰ درصد امتیاز فنی



داشتن سابقه صادراتی



کسب حداقل ۶۰ درصد  
از مجموع امتیازها

# شرکت‌های ۴ ستاره



# شرکت‌های ۴ ستاره



شرکت مهندسی و ساخت برق و کنترل مینا (مکو)



**Tofigh Daru**  
Research & Engineering Co.



# شرکت‌های ۴ ستاره



شرکت پیام اوران نانو فن آوری فردانکر



**SiMedix**  
Simulated Medical Experiences



**TGT Co.**  
شرکت دانش بنیان  
طاها قالب توسی

شرکت نرم افزار ایامن پرداز  
Amnpardaz® Soft. Corporation



گروه مینا  
شرکت مهندسی و ساخت لکوموتیو مینا



**SANTAM**  
Materials Testing Equipment



**TAKGENE**



رهروان سپهر اندیشه

(سهامی خاص)

تولید کننده کنتورهای هوشمند آب و برق



## شرکت‌های ۴ ستاره



# محصولات شرکت های ۴ ستاره

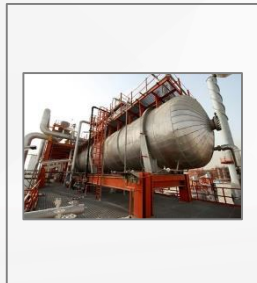
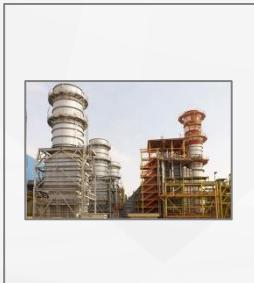
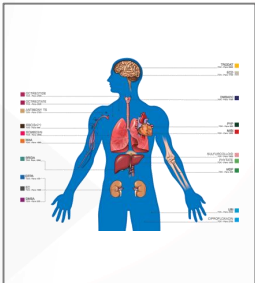
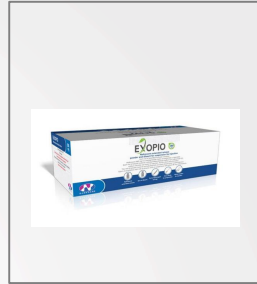
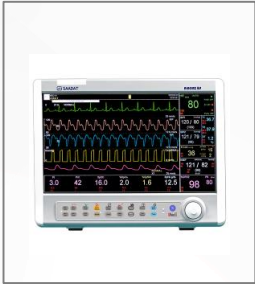

# محصولات شرکت‌های ۴ ستاره

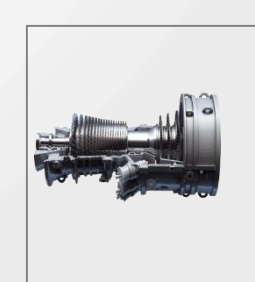
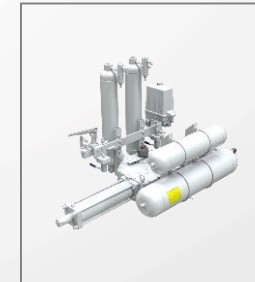
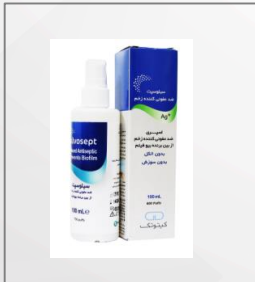
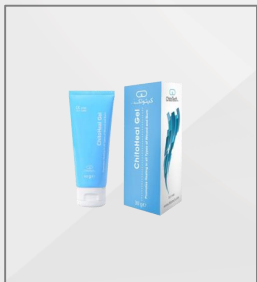
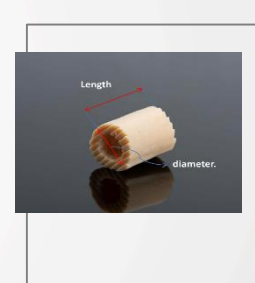
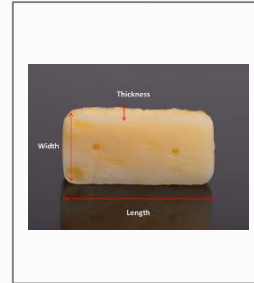
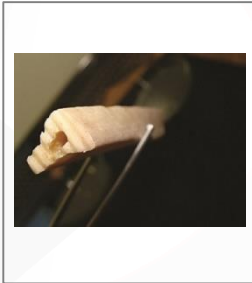
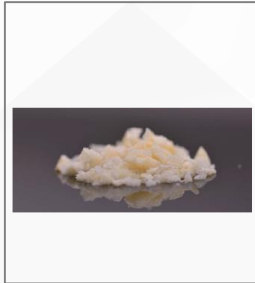
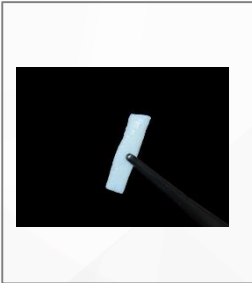
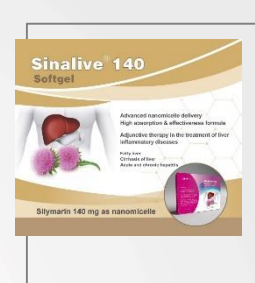
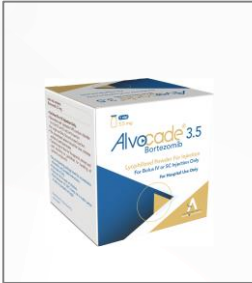

# محصولات شرکت‌های ۴ ستاره

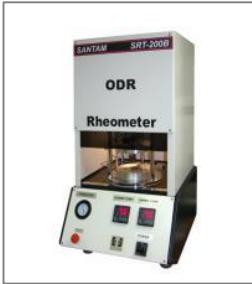
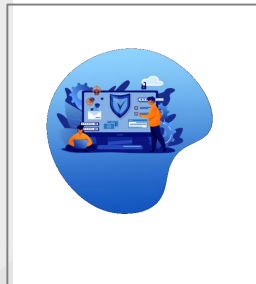
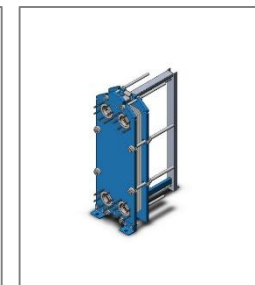
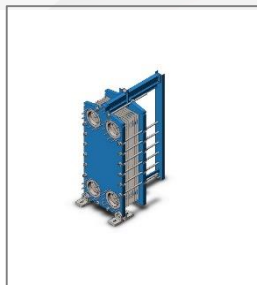
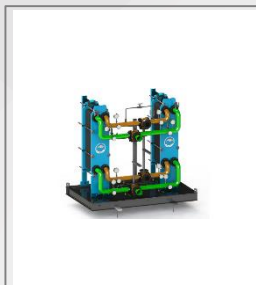

# محصولات شرکت‌های ۴ ستاره

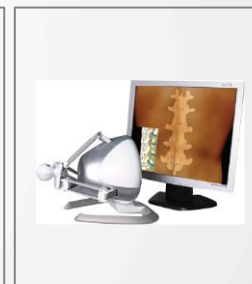
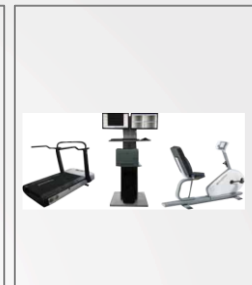
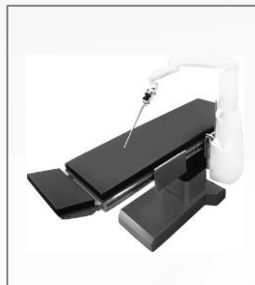
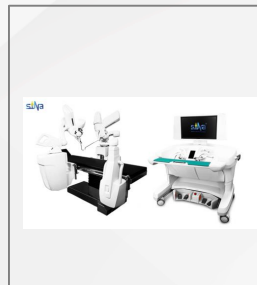
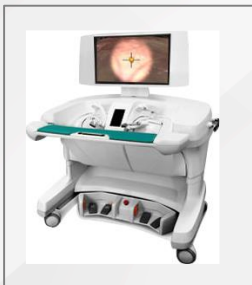
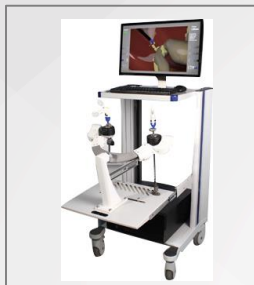



Patient Care Monitor



ventilator system



Brain Function Assessment



Electrocardiogram



Central Monitoring System



nanodaru.com  
info@nanodaru.com

# محصولات Nano Daru Co.



**PACLINAB**  
Paclitaxel albumin bound



**PADYNEX**  
Trastuzumab



**EXOPIO**  
Naltrexone



Digital Meters Single & Three  
Phase



smart meter three  
phase JAM3000CT



Single Phase Digital Meters  
JAM200



Digital Dose Rate Meter

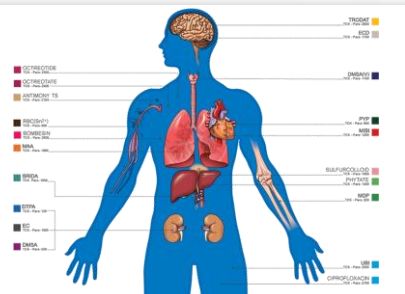

Cold kits



Cobalt point springs - 60



شرکت سامانه جراحی هوشمند پارسه  
Parseh Intelligent Surgical System Co.



parsiss.com



international@parsiss.com

# محصولات Parsiss Co.



navigation system for  
Ear/Nose/Throat



IV2



OV4



Compo™



Parsa-FLEX (PP-Based  
Compounds)



PP AntiBacterial Masterbatch



HRSG



Dearator



WATER TREATMENT &  
WATER DESALINATION SYSTEMS



STEAM THERMAL POWER  
PLANT WATER TUBE BOILERS



Sina Curcumin



Sina Doxosome



Sinalive



Sina Ampholeish



**Robotic Telesurgery System  
(flex model)**



**Hand RoboHab  
Robotic Rehabilitation System**



**Laparoscopic Surgery Assistant  
Robot (Bedside model)**



**Lumbar Puncture Simulator with  
Haptic Sensation (3D model)**



**Laparoscopic Surgery Simulator  
(Conventional model)**



**Sina Robo Sim  
Robotic Surgery Simulator**



nanoalvand.com  
sales@nanoalvand.com

# محصولات Nano Alvand Co.



**Alvocade  
Bortezomib**



**Alvinotec  
Oncology**



**Clastoz  
Rheumatology**



**Danelvin  
Neurology**



novatisteb.com  
info@novatisteb.com

# محصولات Novatis Teb Co.



Dialysis Machine



Portable RO



Reverse Osmosis System  
(RO)



Automated Machinery  
for Dialysis Disposables' Production  
Line



Bio-Implants



Orthopedic products

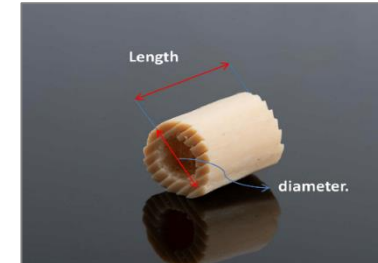

Neurological products



Rhinoplasty products

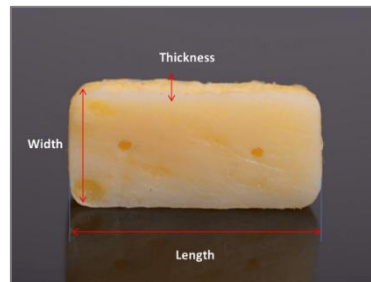

Dental products

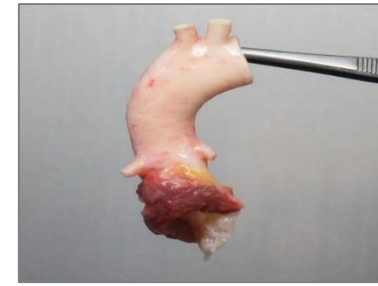

Cardiovascular Products

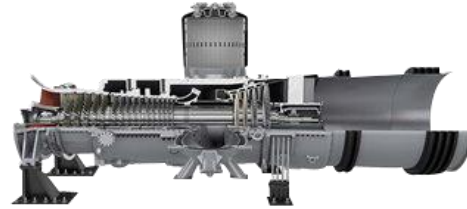

Gas Turbine Blades  
MGT70



Gas Turbine Blades  
MGT30



Gas Turbine Blades 701D



Gas Turbine Blades  
MST-50C



**Ball Valves and Valve Actuators**

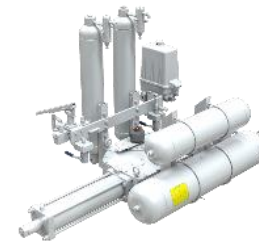

**Gas Over Oil Actuators**



ZIFERONN  
Interferon  $\beta$ -1b



ZIVEK



TECZIFUMA



TEBAZIO



**Hemostatic Products  
based**



**Wound healing products**



**Disinfectant products**



**Health products**



 [apzsharif.com](http://apzsharif.com)  
 [info@apzsharif.com](mailto:info@apzsharif.com)

# محصولات Atieh Pardazan Co.



Eye Cataract Surgery Simulator



APCLOR-SW



Anode for sea  
water electrolysis

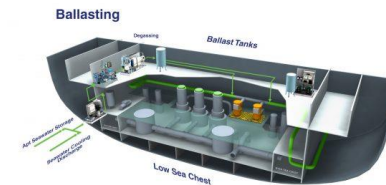

Ship balance water  
management



**TGT Co.**  
شرکت دانش بنیان  
طها قالب توس

🌐 [tgt-phe.com](http://tgt-phe.com)  
✉ [info@tgt-phe.com](mailto:info@tgt-phe.com)

# محصولات TGT Co.



Plate heat exchangers



Fully Welded Block Type Heat Exchanger

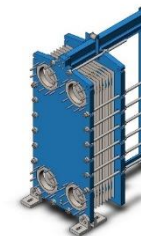

Hamoon plate heat exchanger  
HN30model

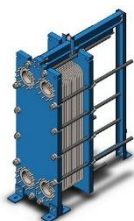

Hamoon plate heat exchanger  
HN25model



Hamoon plate heat exchanger  
HN15 model



mapnaec.com  
info@mapnaec.com

محصولات Mapna Electric & Control Co.



Protection system for electrical equipment of thermal, gas and combined cycle power plants



Scada System



**Tofigh Daru**  
Research & Engineering Co.



[todaco.com](http://todaco.com)



[info@todaco.com](mailto:info@todaco.com)

# محصولات Tofigh Daru Co.



**Glatira**  
Glatiramer Acetate (GA)



**Bortezomib**  
Proteasome Inhibitor (PI)



Intelligent electromagnetic  
water meter



Padvish antivirus



MAPNA 3300 HP Freight  
Locomotive (MAP24)



Torsion & Twist Testing



Rubber Curemeter SRT-200 ODR



Universal Testing Machine



Bending & Re-bending Testing Machine



Impact Testing



Hardness Testing



pnf-co.com  
info@pnf-co.com

محصولات PNF Co.



Wastewater treatment



 [douran.com](http://douran.com)  
 [info@douran.com](mailto:info@douran.com)

محصولات Douran Group



**Wastewater treatment**



system test stress



System Rehabilitation Cardiac



Medical Treadmill



Electrocardiograph



رایان رشد افزار



محصولات Rayan Roshd Afzar



Thermal Camera



rokobioeng.com  
info@rokobioeng.com

Aroko Bioengineering محصولات



Bioreactor/Fermentor



**Probiotic Supplement**

## شرکت‌های سه ستاره



259

تعداد شرکت‌ها



914

تعداد محصولات



## شروط احراز سطح ۳ ستاره

داشتن محصول هایتک با  
حداقل ۳۵ درصد امتیاز فنی

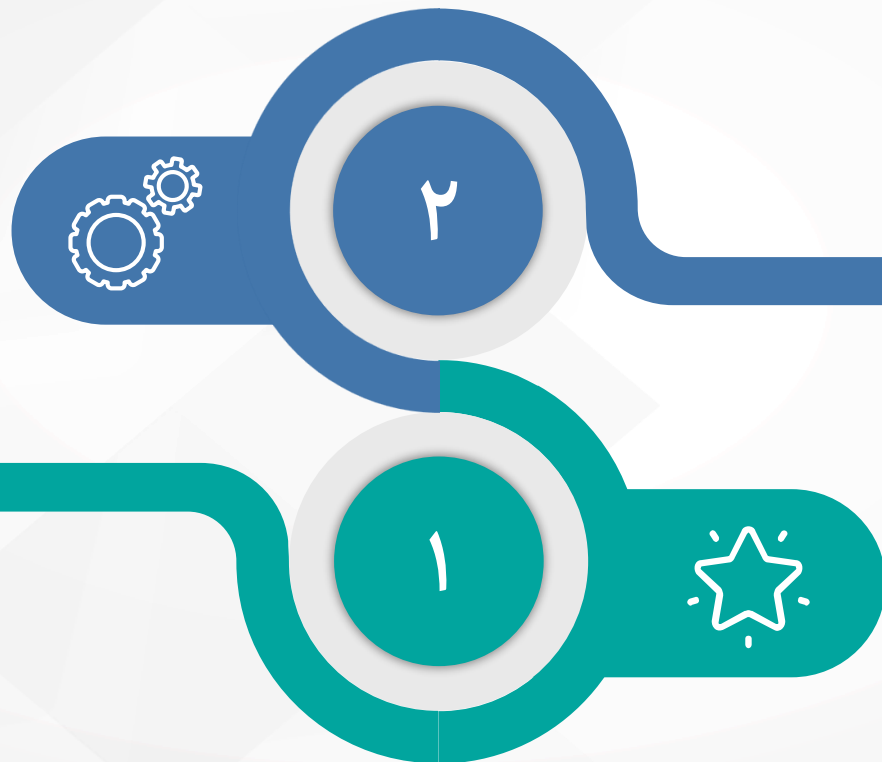

کسب حداقل ۴۰ درصد  
از مجموع امتیازها





PUMPIRAN



Faran Shimi  
Pharmaceutical Co.



شرکت فاتح صنعت کیمیا



نارین  
راهکارهای دیجیتال نوین



شرکت صنایع آذآب  
(سهامی عام)





SAZGAN



DAHIAN  
PEZESHKI PISHRO



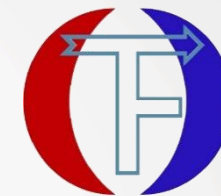

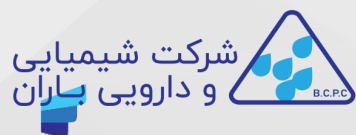



**KOOPA**



# محصولات شرکت های سه ستاره

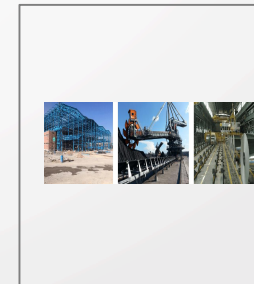
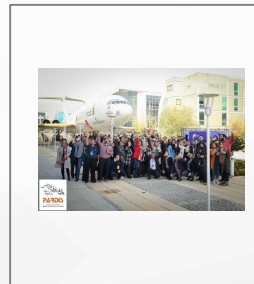
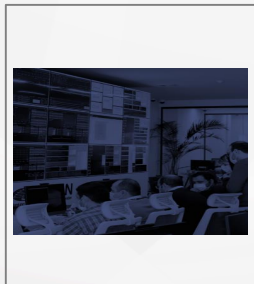
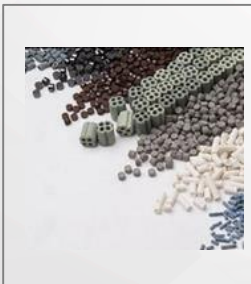
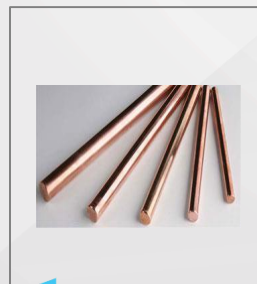
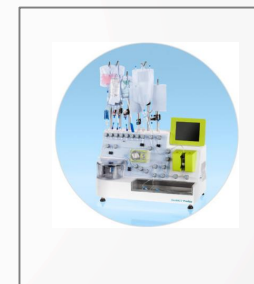
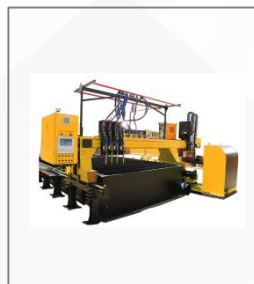
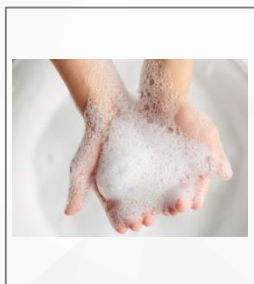
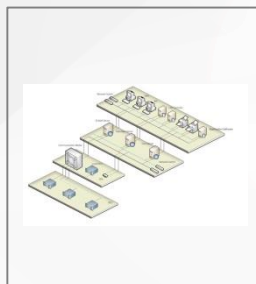
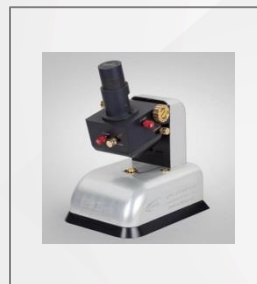
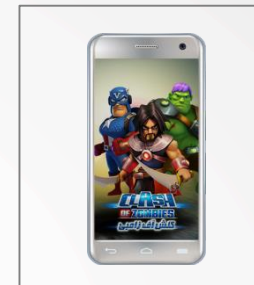
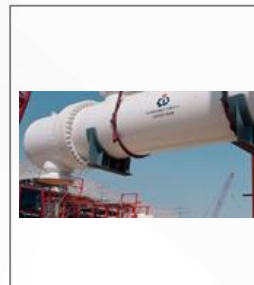
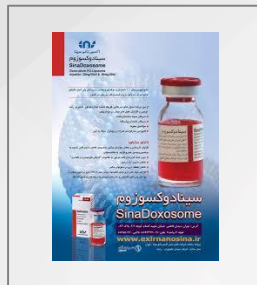

# محصولات شرکت های ستاره

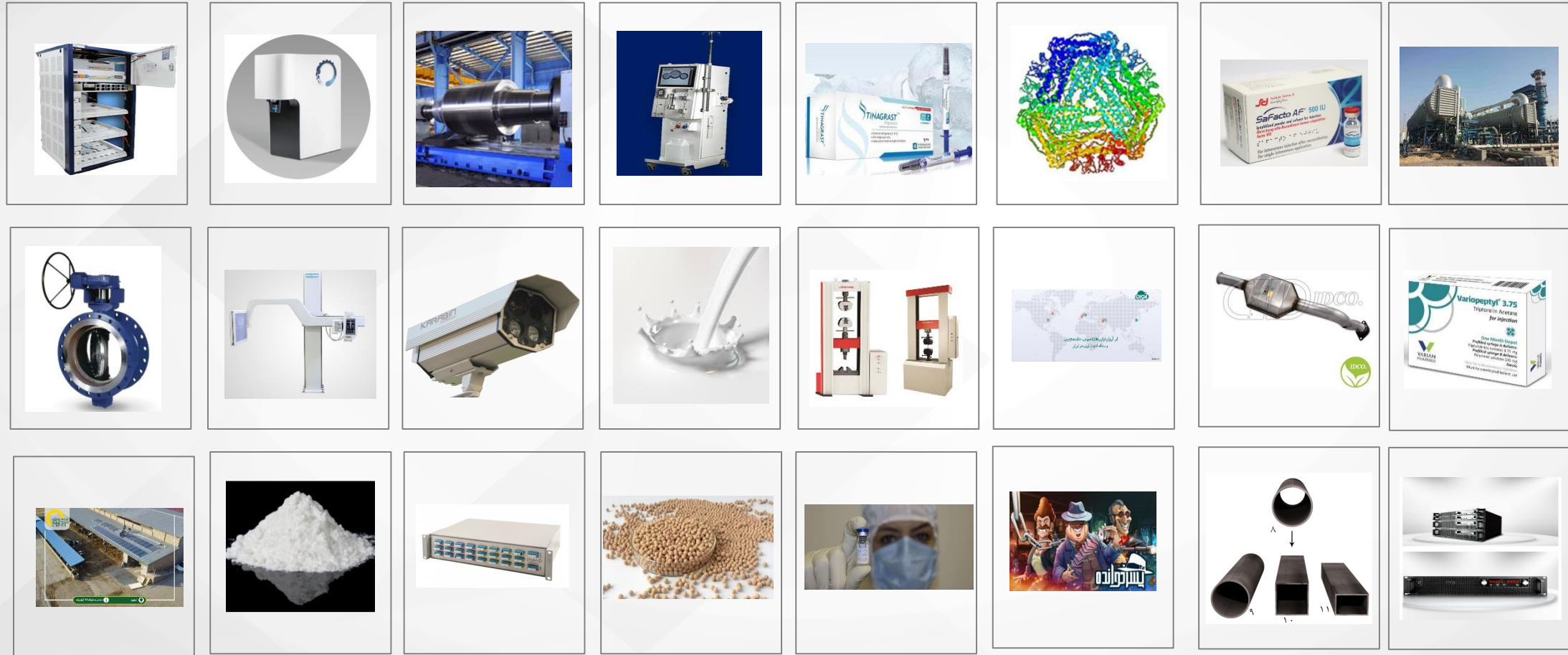

# محصولات شرکت های سه ستاره



# محصولات شرکت های ستاره

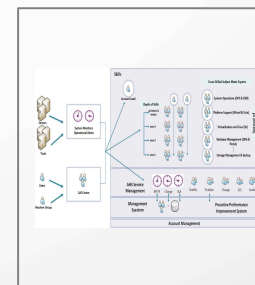
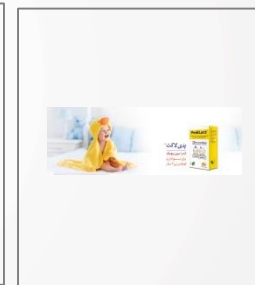
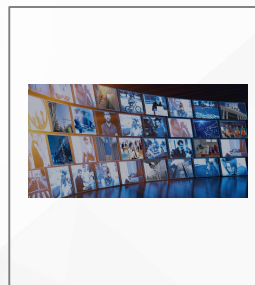
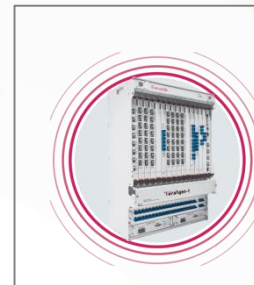
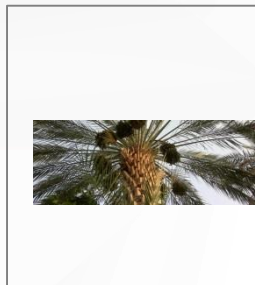
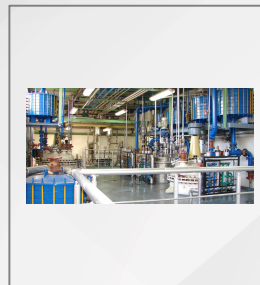



**GE turbine blades and  
nozzles**

# Pumpiran



**NON API Pumps With  
Power of 150 kw and Above**

# AzarAb Industries(LLP)



**Shell and tube heat  
exchanger**

# Nano-Structured Coatings Co.



**Desk Sputter Coater**



**Shell & Tube Heat Exchangers**



The advertisement for SinaDoxosome features a central image of a glass vial containing a red liquid, set against a background of blue water droplets. The text is in Persian and includes the following information:

- سینادوکسوزوم**  
**SinaDoxosome**  
Doxorubicin HCl Liposome  
Injection 20mg/10ml & 50mg/250ml
- کاربردها:**  
• درمان سرطان سینه  
• درمان سرطان کبد  
• درمان سرطان ریه  
• درمان سرطان معده  
• درمان سرطان پانکراس  
• درمان سرطان کلیه  
• درمان سرطان مری  
• درمان سرطان دهان  
• درمان سرطان لوزالمعده  
• درمان سرطان بیضچه  
• درمان سرطان استخوان
- مزایای سینادوکسوزوم:**  
• افزایش اثربخشی درمان  
• کاهش عوارض جانبی  
• افزایش طول عمر بیمار  
• کاهش درد بیمار  
• کاهش تهوع و استفراغ  
• کاهش خستگی  
• کاهش کاهش وزن  
• کاهش کاهش اشتها  
• کاهش کاهش انرژی  
• کاهش کاهش خواب  
• کاهش کاهش حافظه  
• کاهش کاهش تمرکز  
• کاهش کاهش دقت  
• کاهش کاهش سرعت  
• کاهش کاهش دقت

www.exfmanosina.ir

SinaDoxosome



Android Game Clash of Zombies

# Pole Ideal Tajhiz Co.



Universal high speed refrigerated centrifuge

# Nanotechnology System Corporation



Scanning Tunneling Microscope

# Danesh Pajoohesh Fajr



Deep Freezer -80°C with Two Refrigeration Cycles

محصولات: سیستم اسکادا

امتیاز کل: ۴۶

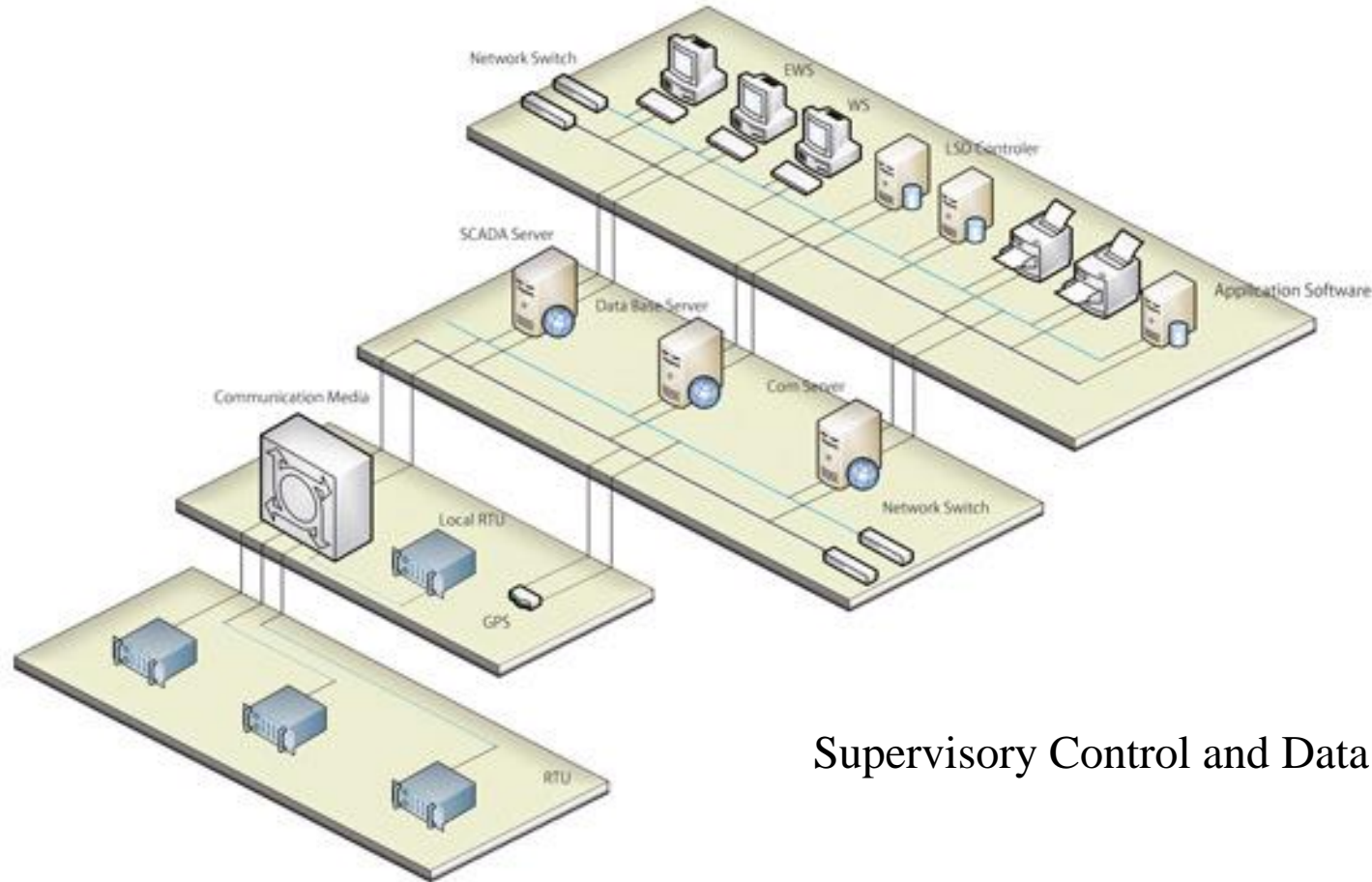

Supervisory Control and Data Acquisition

# Padideh Shimi Jam Co.



synthesized fatty acids for use in industrial scale detergents



CNC Pipe Cutting Machine With Chamfer



Diesel engines



Molecular Seive

# Pharmed Behin Azma



CMV Quantitative Real-Time PCR Detection Kit

# Faran Shimi Pharmaceutical Co.



Faran Shimi  
Pharmaceutical Co.



Buprenorphine

# Artash Composite

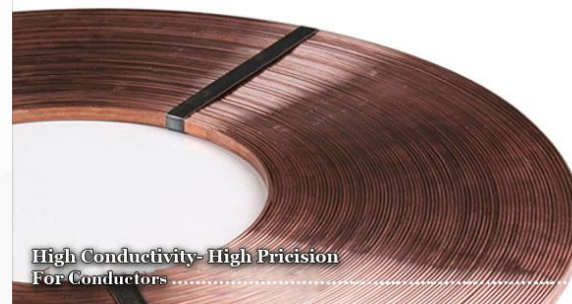

Spot welding Nano-composite electrodes

# Sarv Oil & Gas Industries Development Co.



Gas reforming catalysts in direct iron ore reduction



Telecommunication power supplies



Fara-negin Comprehensive Central Banking System

# Machine Sazi Arak



ماشین سازی اراک  
Machine Sazi Arak



X-MAS TREE & Tubing Head Spool

# Pargasiran



Liquid-Liquid coalescer filter



Car drivers performance monitoring system

# Fara Tahghigh Sepahan International EPC Co.



Iron and Steel Project

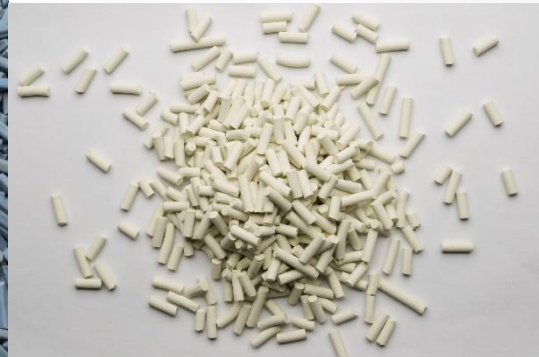

Gas reforming catalysts in direct iron ore reduction

# Temad



Fluvoxamine maleate

# Dorsa Pharmaceutical Co.



Nitroglycerin



Industrial Ozone Generator Machine

# RANA Agro-Industry Corp



کشت و صنعت (عنا) سهامی خاص  
RANA AGRO-INDUSTRY CORP



Propagation of date and walnut trees by tissue culture

# Amin Optical Communications Technology

فانالیبر

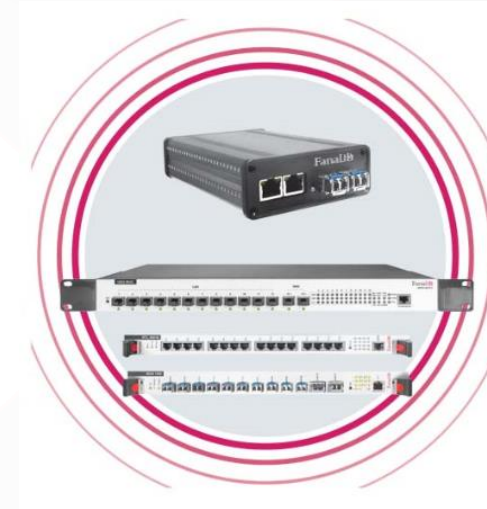
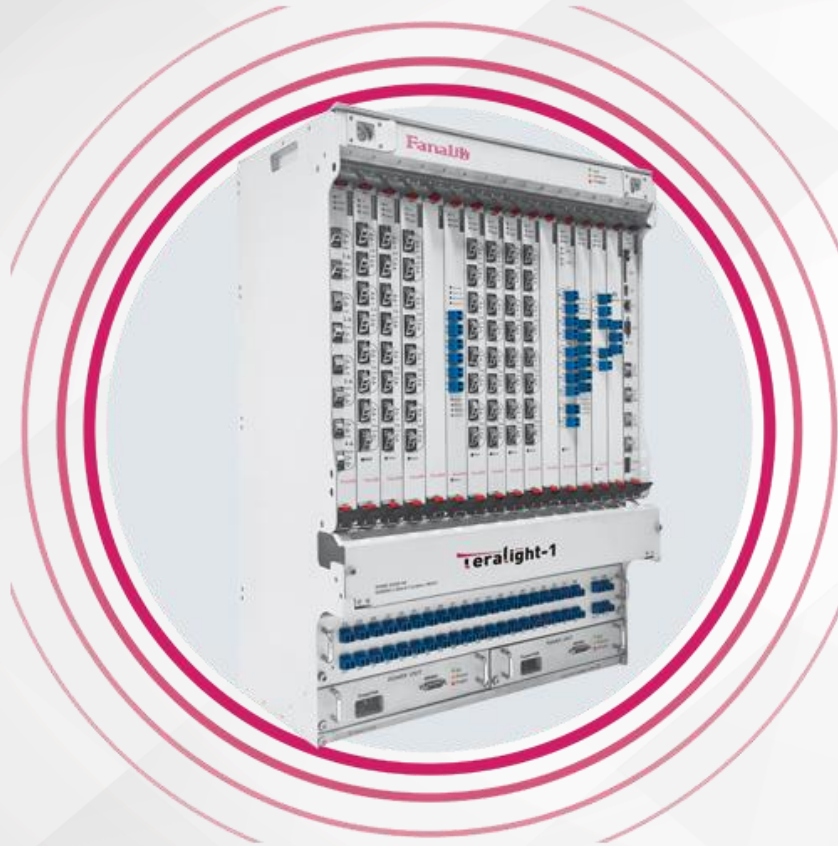

Optical Transmission System with 96 Channels DWDM



Patient Vital Sign Monitoring System

# Mersa Teb Co.

سیستم‌های پزشکی و آزمایشگاهی

مرسا طب تجهیز



Plasma jet device for the treatment of skin lesions

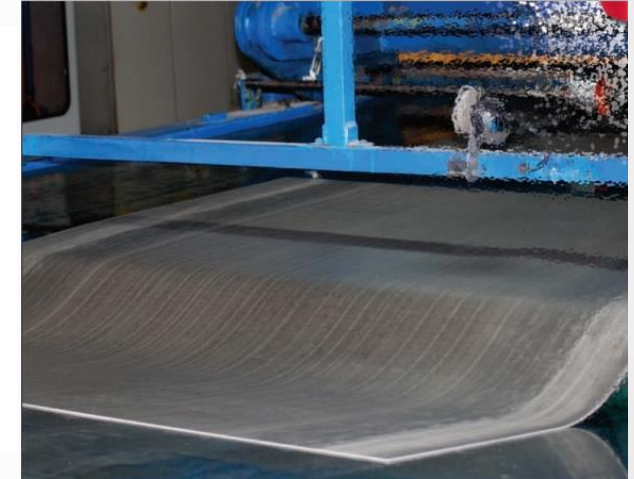

Heavy polymer layers for cars



# Dahian Pezeshki Pishro



Electrocardiograph system

# Parto Negar Persia Co.



Parto Negar Persia Co. Ltd.



Cardiac SPECT

# Turbin Machine m.e.



Siemens gas turbine cold zone parts assembly

# Zist Takhmir Supplements



پدی لاکت®  
قطره سین بیوتیک  
برای نوزادان و  
کودکان زیر ۲ سال

Probiotics for Children

# Kavosh Sanat Toos Co.

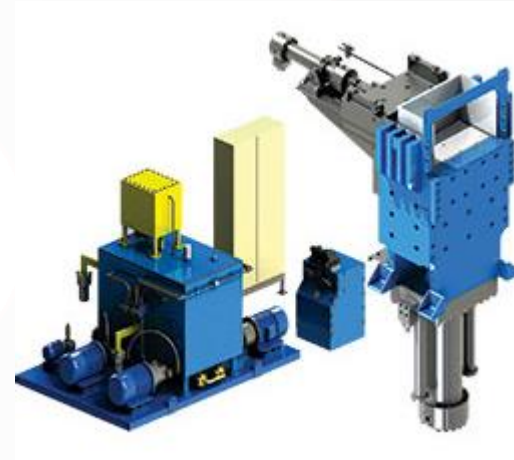

High Speed & High Pressure Centrifugal Pump

# Razin Engineering Plastics



Fiberglass reinforced polyamide

# Lavan Tablo



Medium pressure electrical panels with gas insulation

# Green Biotech Incorporation



Phosphate Bio-fertilizer

# Fan Niroo Co.

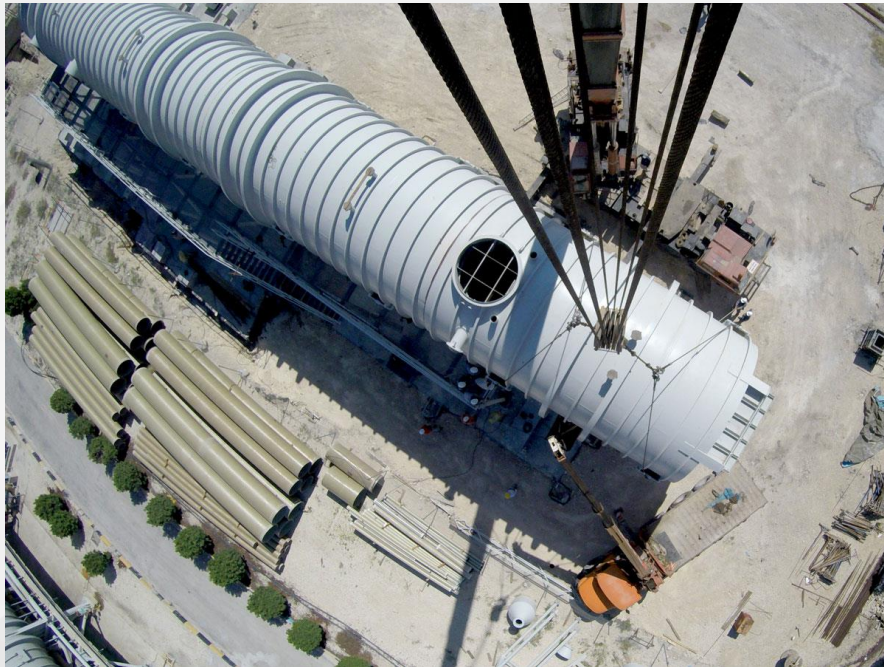

**MED-TVC thermal water desalinators**

# Saman Daroo 8

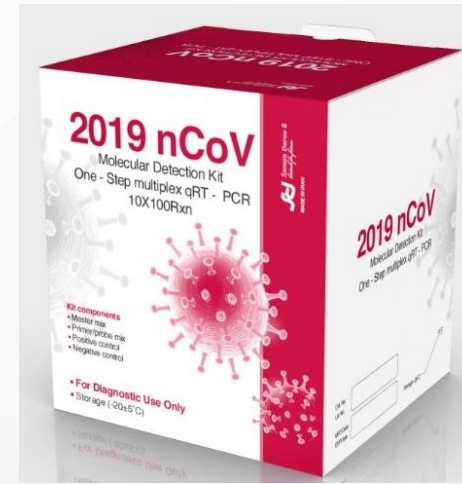

Recombinant human factor eight drug

# PADTAN ELM

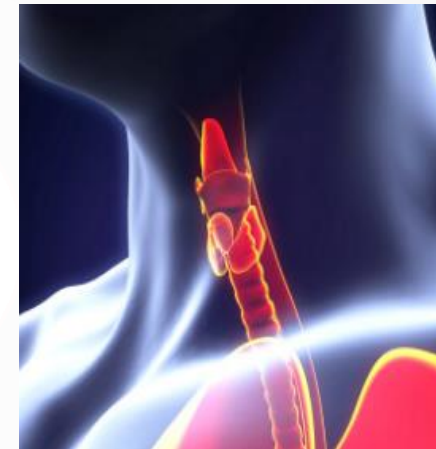
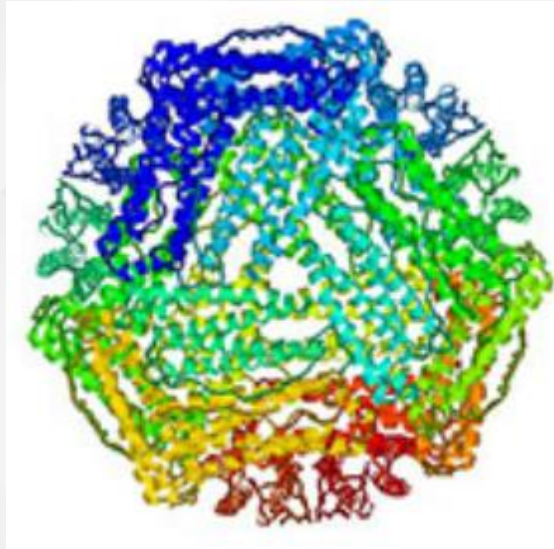

**Ferritin Elisa Test kit**

# AryaTinaGene



**TINAGRAST® Filgrastim**

# ARYA TEB FIROUZ

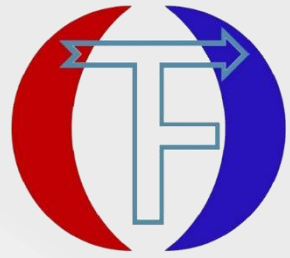

**Hemodialysis Machine**

# Chodansazan Productive Co



Backup rolls of roughing mill

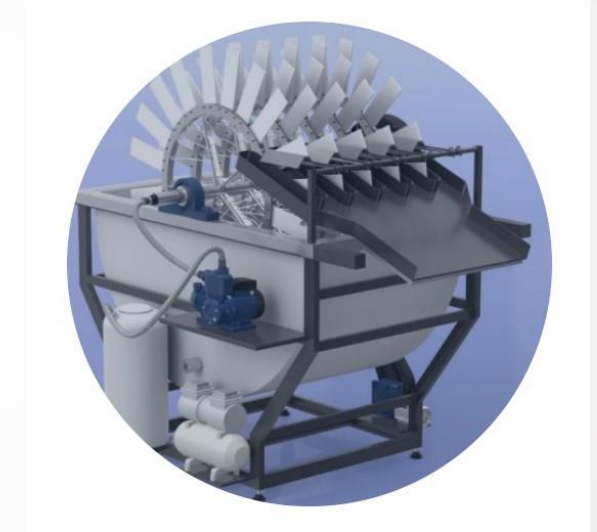

**Ceramic Nanostructured Membranes**

# ITMC

ITMC کارخانجات مخابراتی ایران



Telecommunication power supplies

# Varian Pharmed

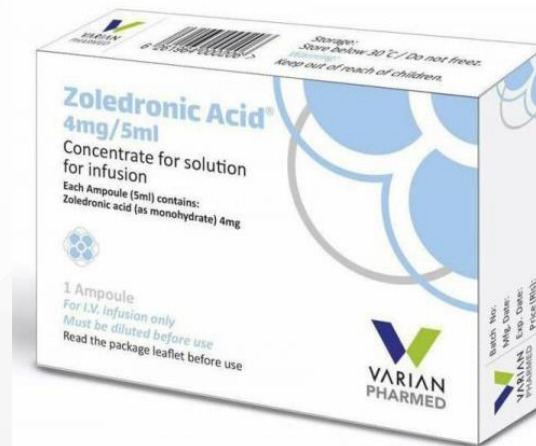
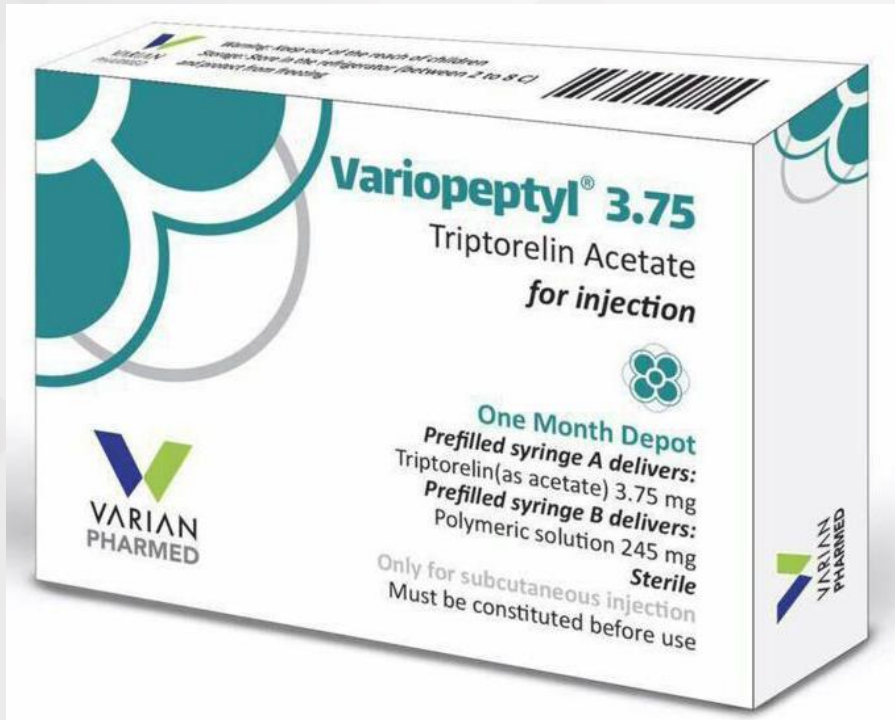

## Variopeptyl® Triptorelin Acetate



**Catalytic converter (catalyst) and coated core (coated monolith)**

# ArvanCloud



Content distribution network and cloud security

# Sanaf Electronic Industries



Universal Tensile tester

# Paya Resin Co.



**Carboxylated SBR latex- Styrene Butadiene Latex**

# Pooya Fanavaran Kosar



**Karabin Embedded ANPR Camera**

# Behyaar Sanat Sepahan



Medical linear accelerator



High pressure ball valve

# Tavan Pajoohan Fanavar Pasargad



**Programmable DC power supplies**



Machine for production of pipes and profiles of heavy steel sections

# Paeezan



Pesarkhande Android Game

# Shifa Pharmmed Industrial Group Co.



**Azithromycin**

# Gaharceram Co.



**Molecular sieves**

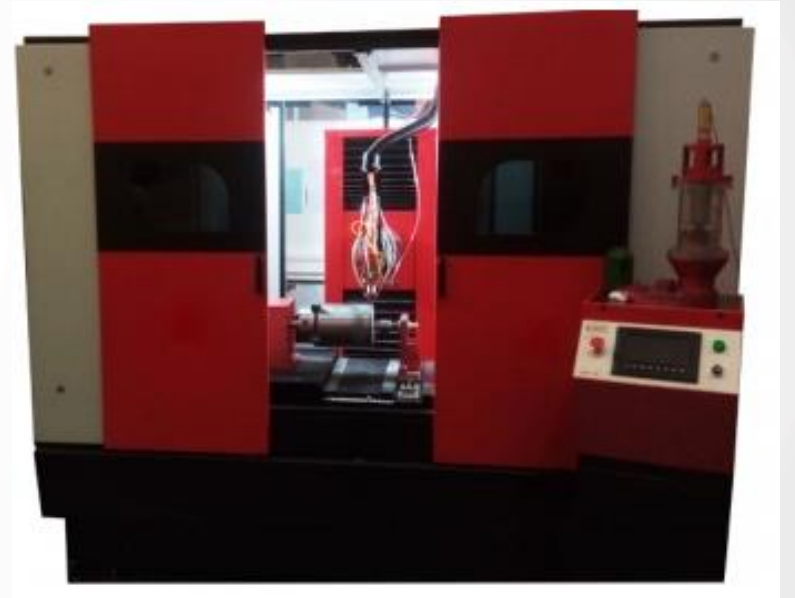

**Optical Transmission System with 40 Channels DWDM**

# Behdash Chemical Co.



شرکت شیمیایی بهداش (سهامی خاص)



**Zeolite powder 4A**

# Noursun Energy



Solar power plant construction services up to 24 MW

# Kousha Fan Pars Co.



Dental Implants

# BARAN CHEMICAL AND PHARMACEUTICAL CO.



Capecitabine



## Voucher-Top up Sales Service



**Hemorrhoid Management System**

# Shahab Industrial Group



High frequency induction systems

# Azmoon Saz Mabna



Universal Tensile tester

# Subar Science & technology Co.



Industrial inkjet printer

# Koopa Pazhooesh Company

**KOOPA**



**Universal hardness tester**

# Taak Resin Kaveh Chemical co.



**Hydroxyl acrylic resins**

# SHATELLAND



Requested video system

# Samim Media & Technology

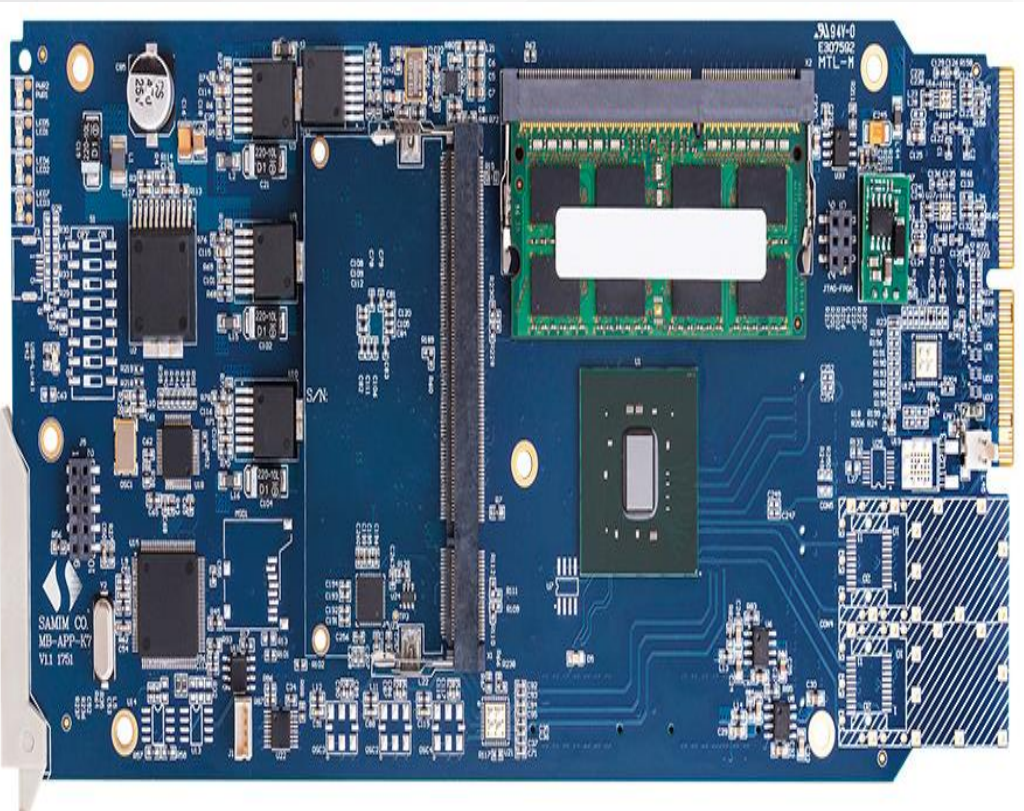

**Audio and video signal processor**

# TurbineMachine m.e.Co

توربین ماشین خاورمیانه  
Turbine Machine m.e.  
تکنولوژی توربین های گاز، بخار و کمپرسور



Design And Manufacture of Industrial Gas Turbine

# Iran Antibiotic Manufacturing Co. (ASICO)



**Enzymatic Synthesis of Amoxicillin**



Electromagnetic Flow Meter

# Sevin plasma surface engineering co.



## Hard-Coating Physical Vapor Deposition System

# Ideh pardazan vatan co.



Flow Forming Machine-Metal spinning



**Triple vaccine (Newcastle, influenza and Gumboro)**

# Payamed Electronic Industries

**PAYAMED**  
ELECTRONIC INDUSTRIES  
صنایع پیامد الکترونیک



**Digital Mammography System**



**Needle gauge (Bourdon gauge) Process pressure measurement**

# Farzaneh Arman Co., Ltd



High speed centrifuges

# Behin Pajouhesh Co.



Biometric Kit

# Persis GenPar Co.



Production of recombinant panitumumab antibody in CHO DG44 host cell at 100



Remote Terminal Unit for automation of electrical equipments

# Eshteal arak Co.



Pressure Jet Burner

# Paya Communication Industries

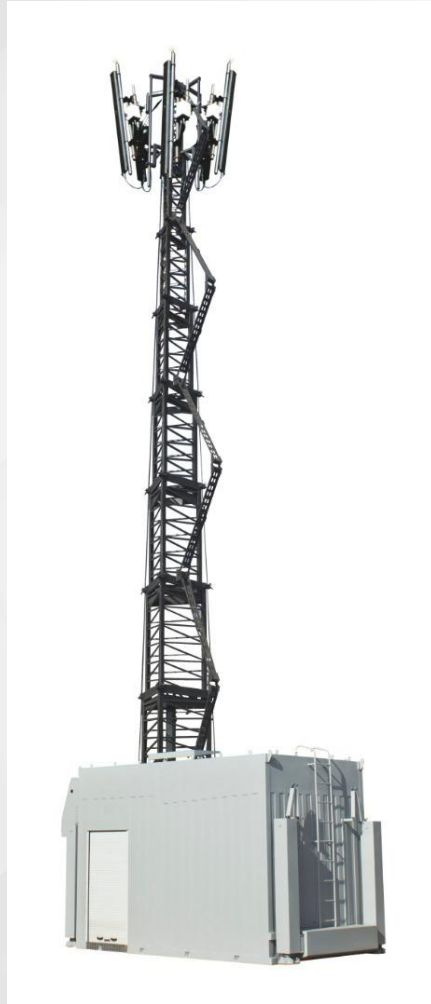

Telecom Mobile Shelter

# Arya Hamrah Samaneh

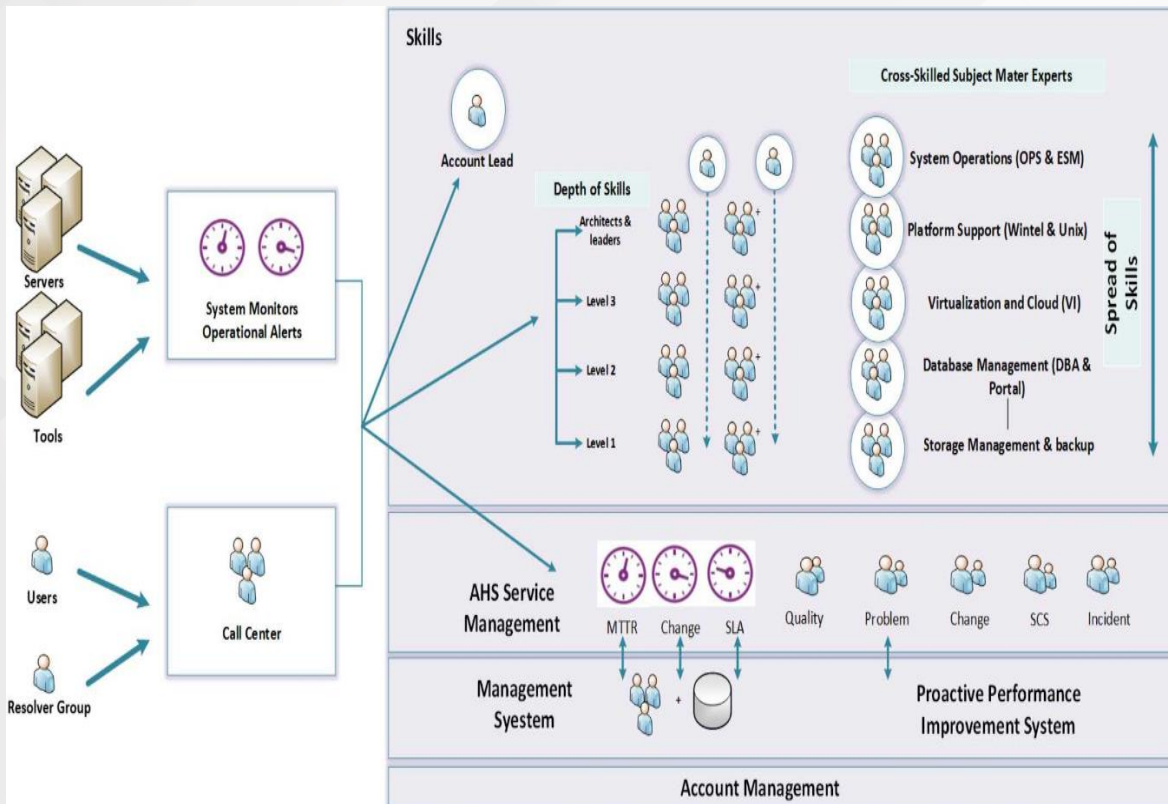

## Data Center Full Services

# شرکت‌های مستعد



تعداد شرکت‌ها 145



تعداد محصولات ۳۵



## شروط احراز سطح مستعد

داشتن محصول هایتک با  
حداقل ۳۵ درصد امتیاز فنی

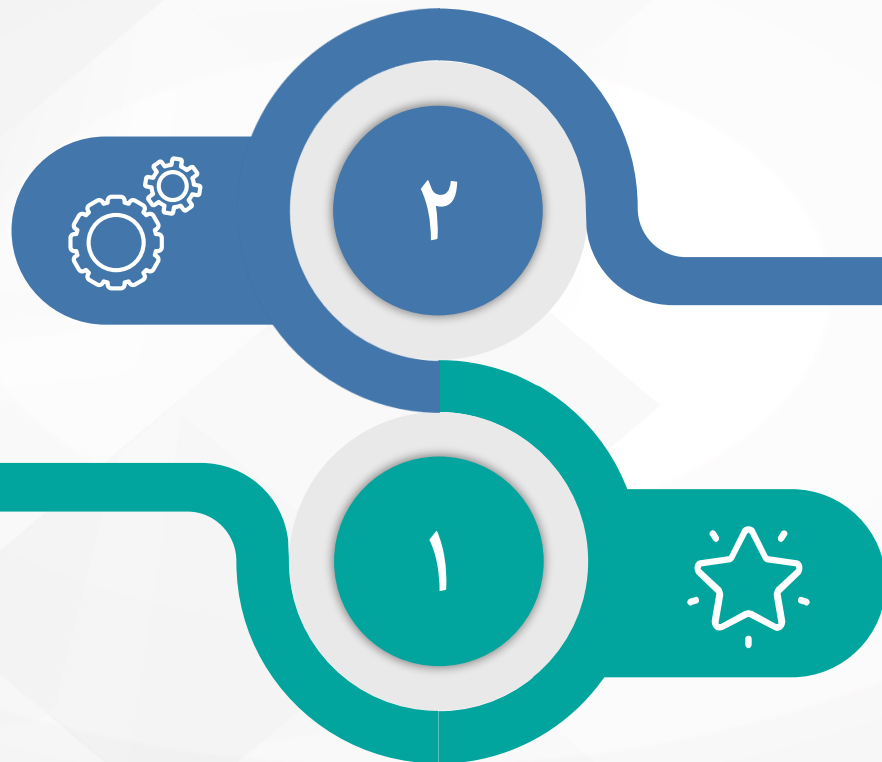

کسب حداقل ۳۰ درصد  
از مجموع امتیازها

# با تشکر و احترام

---



I H T E C C

باشگاه سرآمدان صادرات دانش بنیان